

SINGER
47W63

Form 2931w

(1249)

Printed in U. S. A.

LIST OF PARTS



MACHINE No. 47w63

** A TRADE MARK OF

THE SINGER MANUFACTURING COMPANY

INSTRUCTIONS FOR ORDERING

In ordering from this list, use ONLY the PART number in the FIRST column.

The number stamped on a Sewing Machine Part is the number of the Single Part only, except when the part includes Set Screws, Clamping Screws, Studs and Rollers Spun on, Small Wires riveted, or Parts soldered together, etc., which it is necessary to furnish in combination.

Every combination of parts sent out has its specific number which, although not stamped on Parts (except in above case), must be used when ordering the combination.

Each number always indicates the SAME PART in whatever list it appears, or for whatever Machine.

The letters after some of the numbers indicate the style of finish only, as follows:

- A. Hardened, Polished, Nickel Plated and Buffed.
- B. Polished, Nickel Plated and Buffed.
- C. Hardened only.
- D. Polished only.
- E. Soft, not polished.
- F. Hardened and Polished.
- H. Blued.
- J. Nickel Plated only.
- R. Merlized.
- X. Black Oxide, for Iron and Steel.
- XC. Hardened and Black Oxide, for Iron or Steel.
- Y. Black Nickel Plated only.

These letters MUST BE USED when they appear in the list and AFTER the number, as in the list.

In this series

1 to 1500, 200001 to 201500 and 350001 to 351500 are Screw Numbers.
 1501 to 1800, 201501 to 201800 and 351501 to 351800 are Nut Numbers.
 1801 to 2000, 201801 to 202000 and 351801 to 352000 are Roller Numbers.
 2001 to 50000 and 202001 to 350000 are Numbers of Machine Parts.

The figures in the second column refer only to the plate in which the illustration of the part is shown and are NOT TO BE USED in ordering.

Two or more numbers over a cut indicate that the difference between such parts is not visible in an illustration.

Parts marked with an asterisk (*) are furnished only when repairs are made at the factory.

LIST OF PARTS COMPLETE

FOR

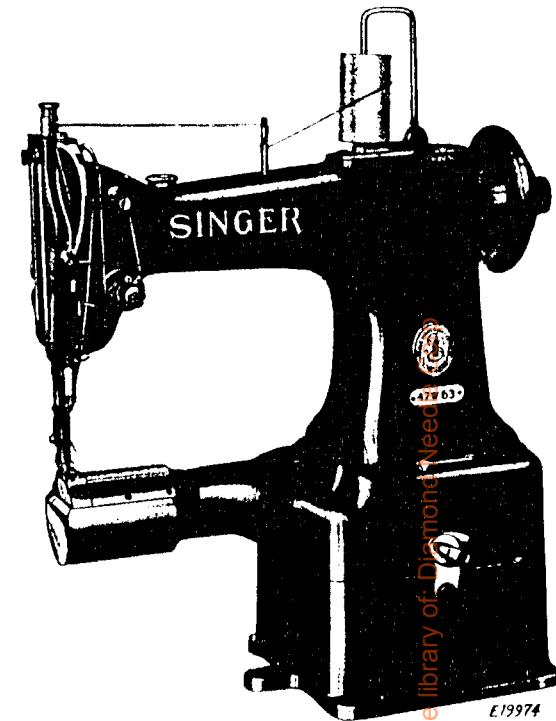

MACHINE No. 47w63

HIGH SPEED. DROP FEED. CYLINDER BED.

ALTERNATING PRESSERS. MECHANICAL OPENER.

FOR TAILORING OVERALLS, GLOVES, ETC.

MAXIMUM STITCH 8 TO THE INCH.

No.	Plate	Name
*233690	----	Arm
203091	17030	" Cap
200278H	17030	" " Screw
202248	17030	" " Washer
203089	17030	" " Spool Holder Base
203090	17030	" " " " " 203089 with 200079H and 204296

INSTRUCTIONS FOR OILING

To ensure easy running and prevent unnecessary wear of the parts which are in movable contact, the machine requires oiling and when in continuous use, "TYPE B" or "TYPE D" OIL, sold only by Singer Sewing Machine Company, should be applied at least twice each day to all oil holes marked "OIL", as instructed in Form 2220w. "TYPE D" OIL is stainless.

INDEX

	PAGE
ACCESSORIES	13
BOBBIN WINDER	13
BINDERS	14
FEED DOGS	16
FOOT LIFTER	14
MACHINE No. 47w63	5
NUMERICAL LIST OF PARTS	21
PRESSER FEET	16
THROAT PLATES	18

From the library of: Diamond Needle Corp

Copyright, U. S. A., 1939, 1940 and 1950
by The Singer Manufacturing Co.
All Rights Reserved for all Countries

PARTS FOR MACHINE No. 47w63

No.	Plate	Name
200585H	17030	Arm Cap Spool Holder Base Screw
204296	17030	" " " " Wire
200079H	17030	" " " " " Hinge Screw
203092	17030	Arm Cap and Spool Holder complete, Nos.203090,203091 and two 200585H
204235	17002	Arm Position Pin (2)
200010E	17002	" Screw (3)
202005	17002	" " Washer (3)
233691	17030	" Shaft with 224392 and 350431E
240802	17030	" " Bushing (back) with 202244
202244	17030	" " " " Oil Packing (wick)
200338C	17030	Arm Shaft Bushing (back) Set Screw
207080	17030	" " " (front) with 202244
202244	17030	" " " " Oil Packing (wick)
200502H	17030	Arm Shaft Bushing (front) Oil Packing Thumb Screw
200338C	17030	Arm Shaft Bushing (front) Set Screw
235003	17002	" " Connection Belt
224200	17062	" " " " Pulley with 200327C, 200602C and two 202253
200602C	17002	Arm Shaft Connection Belt Pulley Position Screw
200327C	17002	Arm Shaft Connection Belt Pulley Set Screw
202253	17002	Arm Shaft Connection Belt Pulley Spring Flange
233692	17003	Arm Shaft Connection Belt Timing Plate
200164B	17003	" " " " " " " Screw (2)
224392	17030	Arm Shaft Oil Packing (wick)
350431E	17030	" " " " Stop Screw
235096	17030	Balance Wheel (disc) (belt groove 2-1/2 in. diam.) with 200328C and 200335C
200328C	17030	Balance Wheel Position Screw
200335C	17030	" " Set Screw
*233693	-----	Bed (cylinder) with 201461C and 213380
233607	17044	" " Cap
222404	17044	" " " Position Pin
200100D	17044	" " " Screw (2)
213787	17044	" " " End Cover
213890	17044	" " Base (4 in. high)
203184	17044	" " Clamp
200262H	17044	" " " Hinge Screw
202622	17044	" " " Packing Washer
200728B	17044	" " " Thumb Screw
203185	17044	" " " Washer
202618	17044	" " " Hinge
200030H	17044	" " " Screw (6)
221174	17044	" " " Slide (back)
233643	17044	" " " Clamp Plate (back)
200459D	17044	" " " " " " " Thumb Screw
226071	17044	Bed Slide Clamp Plate (back) Thumb Screw Washer

PARTS FOR MACHINE No. 47w63

No.	Plate	Name
233609	17044	Bed Slide Clamp Plate (front)
200580H	17044	" " " " " Screw (4)
203470	17024	Bobbin
*235099	-----	" Case
203648	17024	" " Latch
*202056	-----	" " " Pin
203473	17024	" " " Plunger
203474	17024	" " " Spring
233636	17024	" " " Lever
*233640	-----	" " " Eccentric
221147	17024	Bobbin Case Lever Eccentric Position Pin
203576	17024	Bobbin Case Lever Fulcrum with 203579
200110D	17024	" " " " " Screw
203578	17024	" " " " Slide
203579	17024	" " " " Stud
241674	17024	" " " Oiling Felt
241675	17024	" " " " Retainer
350405C	17024	" " " " " Screw
203214	17024	" " " Tension Spring
200984C	17024	" " " " " Regulating Screw
200594C	17024	Bobbin Case Tension Spring Screw
203216	17024	" " " Washer (cloth)
235100	17024	Bobbin Case complete, Nos.200594C, 200984C, 202056, 203214, 203216, 203473, 203474, 203648, 235099, 241674, 241675 and two 350405C
233610	17044	Face Plate
200462H	17044	" " Thumb Screw
233694	17038	Feed Bar with 213610
213298	17038	" " " Connecting Link with two 350411C
350411C	17038	Feed Bar Connecting Link Pinch Screw
200935F	17038	" " " " " Screw Stud
201531E	17038	" " " " " " Nut
213610	17038	" " " " " Stud
212307	17038	" Dog, for 233702
350149E	17038	" " " Screw, for use with platform throat plates
221163	17038	Feed Dog Stop Washer, for use with platform throat plates
235082	17002	Feed Driving Eccentric Regulating Bracket
233612	17002	Feed Driving Eccentric Regulating Bracket 235082 with 224200, two each 201408C and 201525E
201408C	17002	Feed Driving Eccentric Regulating Bracket Hinge Screw
201525E	17002	Feed Driving Eccentric Regulating Bracket Hinge Screw Nut
202301	17002	Feed Driving Eccentric Regulating Bracket Plunger
202595	17002	Feed Driving Eccentric Regulating Bracket Plunger Spring

PARTS FOR MACHINE No. 47w63

No.	Plate	Name
200607C	17002	Feed Driving Eccentric Regulating Bracket Plunger Spring Stop Screw
201408	17002	Feed Driving Eccentric Regulating Bracket Stop Screw
201525E	17002	Feed Driving Eccentric Regulating Bracket Stop Screw Nut
200429F	17002	Feed Driving Eccentric Regulating Screw
200383C	17002	Feed Driving Eccentric Regulating Screw Check Screw
235011	17038	Feed Driving Rock Shaft
233614	17038	" " " " Bearing
201525E	17038	" " " " Nut
235066	17038	" " " " Bushing
200346C	17038	" " " " Set Screw
203244	17038	Feed Driving Rock Shaft Collar with two 200393C
200393C	17038	Feed Driving Rock Shaft Collar Set Screw
235842	17002	Feed Driving Rock Shaft Connection with 200054E and 202277
200919C	17002	Feed Driving Rock Shaft Connection Hinge Screw
201522E	17002	Feed Driving Rock Shaft Connection Hinge Screw Nut
202277	17002	Feed Driving Rock Shaft Connection Oil Packing (wick)
200054E	17002	Feed Driving Rock Shaft Connection Pinch Screw
210559	17030	Feed Driving Rock Shaft Connection Stop Collar with two 200378C
200378C	17030	Feed Driving Rock Shaft Connection Stop Collar Set Screw
221164	17038	Feed Driving Rock Shaft Crank with 200038C
200038C	17038	Feed Driving Rock Shaft Crank Pinch Screw
233695	17038	Feed Lifting Cam with 200392C and 200447C
200447C	17038	Feed Lifting Cam Position Screw
233696	17038	" " " Retainer
200583H	17038	" " " Screw
200392C	17038	" " " Set Screw
233615	17040	" Regulating Spindle with 202311, 202443 and 202619
*202311	-----	Feed Regulating Spindle Head
202443	17030	" " " " Pin
202619	17030	" " " " Position Pin
203061	17044	Foot Lifter Lifting Lever
200262H	17044	" " " " Hinge Screw
233390	17044	" " " " Washer
233361	17044	Foot Lifter Lifting Lever Position Spring

PARTS FOR MACHINE No. 47w63

No.	Plate	Name
200273D	17044	Foot Lifter Lifting Lever Position Spring Screw
*203522	-----	Hook (sewing)
203523	17024	" 203522 with 203525 and two 201253F
238250	17024	Hook and Bobbin Case complete, Nos. 203523 and 235100
233697	17024	Hook Bevel Gear Socket, 18 teeth
200556H	17024	" " " " Screw
233698	17003	" " Pinion with two 200386C
200386C	17003	" " " " Set Screw
235015	17003	" Driving Counter Shaft
235016	17003	" " " " Bushing (back)
200346C	17003	Hook Driving Counter Shaft Bushing (back) Set Screw
235017	17003	Hook Driving Counter Shaft Bushing (front)
200346C	17003	Hook Driving Counter Shaft Bushing (front) Set Screw
235018	17003	Hook Driving Counter Shaft Gear with 200382C and 200398C
200398C	17003	Hook Driving Counter Shaft Gear Position Screw
200382C	17003	Hook Driving Counter Shaft Gear Set Screw
235019	17038	Hook Driving Counter Shaft Oil Tube (brass)
233699	17003	Hook Driving Shaft
235021	17003	" " " Bushing (back)
200346C	17003	" " " " Set Screw
213380	17003	Hook Driving Shaft Bushing (front)
201461C	17003	" " " " " "
203244	17003	Hook Driving Shaft Collar (front) with two 200393C
200393C	17003	Hook Driving Shaft Collar (front) Set Screw
235064	17003	Hook Driving Shaft Connection Belt Pulley with 202253 and two 201254C
201254C	17003	Hook Driving Shaft Connection Belt Pulley Set Screw
202253	17003	Hook Driving Shaft Connection Belt Pulley Spring Flange
235018	17003	Hook Driving Shaft Gear with 200382C and 200398C
200398C	17003	Hook Driving Shaft Gear Position Screw
200382C	17003	" " " " " Set Screw
203525	17024	" Gib
201253F	17024	" " Screw
233707	17024	" Saddle with 206758 and 233708
206758	17024	" " Oil Packing (wick)
233708	17024	" " Oiling Felt
200541E	17024	" " " " Screw (2)
225837	17024	" " " " Washer (2)

For the library: Diamond Needle Corp

No.	Plate	Name
233758	17024	Hook Saddle complete, Nos. 200110D, 200556H, 203576, 203578, 233636, 233697, 233707, 238237 and 238250
238237	17024	Hook Washer with 233640 and three 221147
208545	17041	Lifting Bell Crank
233624	17040	" " " Driving Crank
208547	17040	" " " " "
		Link
201012C	17040	Lifting Bell Crank Driving Crank Position Screw
200383C	17040	Lifting Bell Crank Driving Crank Set Screw
200996C	17041	Lifting Bell Crank Stop Screw
229626	17041	" Presser Foot
200074F	17041	" " " Screw
233625	17040	Needle Bar with 200125F, 200175D and 204250
233829	17040	Needle Bar Bushing
200352C	17040	" " " Set Screw
233642	17040	" " Connecting Link
264714	17040	" " " Stud with 200072C and 202277
202277	17040	Needle Bar Connecting Stud Oil Packing (wick)
200072C	17040	Needle Bar Connecting Stud Pinch Screw
233627	17040	" " Crank with 200335C, 200383C, 200428C and 201012C
203172	17040	Needle Bar Crank Friction Washer
200428C	17040	" " " Position Screw
200335C	17040	" " " Set Screw
204250	17040	" " Thread Guide
200175D	17040	" " " Screw
200125F	17040	" Set Screw
238246	17041	Presser Bar with 200074F
233763	17041	" " Bushing
200363AL	17041	" " " Set Screw
202554	17041	" " Lifter
200653C	17041	" " Hinge Screw
233628	17041	" " Lifting Bracket with 200054E
200975F	17041	Presser Bar Lifting Bracket Guide Screw
200054E	17041	Presser Bar Lifting Bracket Pinch Screw
233634	17041	Presser Bar Position Guide
202338	17041	" " " " Lever with 200086F
200086F	17041	Presser Bar Position Guide Lever Pinch Screw
200352C	17041	Presser Bar Position Guide Set Screw
236089	17041	" " Spring
202346	17041	" " " Stop Rod
200492H	17041	" " Thumb Screw (pressure regulating)

No.	Plate	Name
200475H	17041	Presser Bar Thumb Screw Thumb Set Screw
202355	17041	Presser Bar Thumb Screw Thumb Set Screw Packing (brass)
224372	17040	Take-up Lever
208557	17040	" " Driving Stud with 202277
202277	17040	" " " " Oil Packing (wick)
202400	17040	Take-up Lever Hinge Stud with 202423
202423	17040	" " " " Oil Packing (wick)
200383C	17040	Take-Up Lever Hinge Stud Set Screw
208558	17040	" " Oil Guard with 223655 and 224572
200161H	17040	Take-up Lever Oil Guard Screw
208568	17040	" " " Leader
202254	17040	" " " Packing (wick)
223655	17040	" " Oiling Felt
224572	17040	" " " Rivet
244048	15107	Tension Disc (back)
244049	15107	" " (front)
202404	17041	" Plunger
233629	17041	" Release Slide
208560	17041	" " Spring
244061	15107	" " Washer
202407	15107	" Spring
263106	15106	" Washer
200625F	15107	" Stud with 204925
200061C	15107	" Set Screw
204925	15107	" Washer
201572H	15107	" Thumb Nut
244062	15107	Tension complete, Nos. 200625F, 201572H, 202407, 202410, 244048, 244049, 244061 and 263106
202410	15107	Thread Controller Spring
241443	15107	" " " Stop
200132E	15107	" " " Screw
202412	17030	" Guide (on top of Arm)
202413	15107	" " "
202414	15107	" " "
202415	15107	" " "
202417	15107	" " "
52171	17040	" " (on Needle Bar Bushing)
200582H	15107	" " Screw
200355H	15107	" " Set Screw
200368H	15107	" " " "
202091	15107	" Retainer Sleeve
202092	15107	" " Spring
204058	15107	" " Stud
200368H	15107	" " " Set Screw
204059	15107	Thread Retainer complete, Nos. 202091, 202092 and 204058
233702	17038	Throat Plate, 46 needle hole, for needle sizes 16 and 18, for 212307
200577AL	17038	Throat Plate Screw (2)
233630	17041	Vibrating Presser Bar

From the library of Diarrhoea Needle Co.

ORDERS

No.	Plate	Name
206707	17049	Vibrating Presser Foot
233783	17039	Throat Plate, 50 needle hole, for needle sizes 14 and 15, for 212220

FEED DOGS

212220	17039	Feed Dog, for 233783, 233784, 233787 and 233788
212221	17039	Feed Dog, for 233783, 233784, 233787 and 233788
212281	17039	Feed Dog, for 233778
212282	17039	" " " 233778
212290	17039	" " " 233782
212307	17038	" " " 233702
211407	17039	" " " 233801

PRESSER FEET

204601	17049	Lifting Presser Foot, for 206707 and 206716
204602	17048	Lifting Presser Foot, for 206672, 206673, 206707 and 206715 to 206717
204603	17048	Lifting Presser Foot, for 206672, 206673, 206707 and 206715 to 206717
204604	17047	Lifting Presser Foot, for 206668, 206675, 206678, 206714 and 206719
204605	17047	Lifting Presser Foot, for 206668, 206675, 206678, 206714 and 206719
204606	17049	Lifting Presser Foot, for 206676, 206699 and 206700
204607	17049	Lifting Presser Foot, for 206707 and 206716
204609	17046	Lifting Presser Foot, for 206672, 206673, 206681, 206707 and 206715 to 206717
204610	17049	Lifting Presser Foot, for 206676, 206699 and 206700
204595	17049	Lifting Presser Foot, for 204620
204611	17045	" " " " 204620 204634, 206698, 206705, 206706 and 229620

PRESSER FEET

No.	Plate	Name
204612	17045	Lifting Presser Foot, for 204620, 204634, 206698, 206705, 206706 and 229620
206674	17047	Lifting Presser Foot, 40 needle hole, for 206668, 206675, 206678, 206714 and 206719
221182	17045	Lifting Presser Foot, for 204620, 204634, 206698 and 229620
206697	17045	Lifting Presser Foot, for 204620, 204634, 206698, 206701 and 229620
229625	17045	Lifting Presser Foot, for 204620, 204634, 206698, 206705, 206706 and 229620
229633	17048	Lifting Presser Foot, for 206672, 206673, 206707 and 206715 to 206717
206695	17045	Lifting Presser Foot, for 204620, 204634, 206698 and 229620
206694	17048	Lifting Presser Foot, for 204621, 206692 and 206693
204640	17045	Lifting Presser Foot, for 204620, 204634, 206698 and 229620
229626	17041	Lifting Presser Foot, for 204620, 204634, 206698 and 229620
206662	17046	Lifting Presser Foot, 46 needle hole, for 206663
206664	17046	Lifting Presser Foot (grooved), 46 needle hole, for heavy cording, for 206665
206696	17045	Lifting Presser Foot, 46 needle hole, for 204620, 204634, 206698 and 229620
229628	17048	Lifting Presser Foot, for 204621, 206692 and 206693
229629	17046	Lifting Presser Foot, for 206691 and 229630
206702	17046	Lifting Presser Foot, for 206703 and 206704
204634	17045	Vibrating Presser Foot, for 204611, 204612, 204640, 206695 to 206697, 221182, 229625 and 229626
206663	17046	Vibrating Presser Foot, for 206662
206678	17047	" " " " 204604, 204605 and 206674
206672	17046	Vibrating Presser Foot, for 20462, 204603, 204609 and 229633
206673	17046	Vibrating Presser Foot, for 204602, 204603, 204609 and 229633
206675	17047	Vibrating Presser Foot, for 204604, 204605 and 206674
206691	17046	Vibrating Presser Foot, for 229629
206692	17048	" " " " 206694 and 229628
206700	17049	Vibrating Presser Foot, for 204606 and 204610
206703	17046	Vibrating Presser Foot, for 206702
206705	17045	" " " " 204611, 204612 and 229625

PRESSER FEET

No.	Plate	Name
206706	17045	Vibrating Presser Foot, for 204611, 204612 and 229625
206714	17047	Vibrating Presser Foot, for 204604, 204605 and 206674
206719	17047	Vibrating Presser Foot, for 204604, 204605 and 206674
206698	17045	Vibrating Presser Foot, for 204611, 204612, 204640, 206695 to 206697, 221182, 229625 and 229626
229630	17046	Vibrating Presser Foot, for 229629
204621	17048	" " " " 206694 and 229628
229620	17045	Vibrating Presser Foot, for 204611, 204612, 204640, 206695 to 206697, 221182, 229625 and 229626
206704	17046	Vibrating Presser Foot, for 206702
206701	17045	" " " " binding slippers, for 206697
206716	17046	Vibrating Presser Foot, for 204601 to 204603, 204607, 204609 and 229633
206665	17046	Vibrating Presser Foot, for 206664
206668	17047	" " " " 204604, 204605 and 206674
206681	17046	Vibrating Presser Foot, for 204609
206676	17049	" " " " 204606 and 204610
206715	17046	Vibrating Presser Foot, for 204602, 204603, 204609 and 229633
206699	17049	Vibrating Presser Foot, for 204606 and 204610
206707	17046	Vibrating Presser Foot, for 204601 to 204603, 204607, 204609 and 229633
206693	17048	Vibrating Presser Foot, for 206694 and 229628
206717	17046	Vibrating Presser Foot, for 204602, 204603, 204609 and 229633
204620	17041	Vibrating Presser Foot, for 204595, 204611, 204612, 204640, 206695 to 206697, 221182, 229625 and 229626

THROAT PLATES

233778	17039	Throat Plate, 46 needle hole, for needle sizes 16 and 18, for 212281 and 212282
233782	17039	Throat Plate, 46 needle hole, for needle sizes 16 and 18, for 212290
233783	17039	Throat Plate, 50 needle hole, for needle sizes 14 and 15, for 212220 and 212221
233784	17039	Throat Plate, 46 needle hole, for needle sizes 16 and 18, for 212220 and 212221

THROAT PLATES

No.	Plate	Name
233787	17039	Throat Plate, 50 needle hole, for needle sizes 14 and 15, for 212220 and 212221
233788	17039	Throat Plate, 46 needle hole, for needle sizes 16 and 18, for 212220 and 212221
233702	17038	Throat Plate, 46 needle hole, for needle sizes 16 and 18, for 212307
233801	17039	Throat Plate, 50 needle hole, for needle sizes 14 and 15, for 211407

SINGER Needles should be used
in SINGER Machines.
These Needles and their Containers
are marked with the
Company's Trade Mark "SIMANCO. ***" I

Needles in Containers marked
"FOR SINGER MACHINES"
are NOT **SINGER** made needles. 2

16615 - 1/2

259431

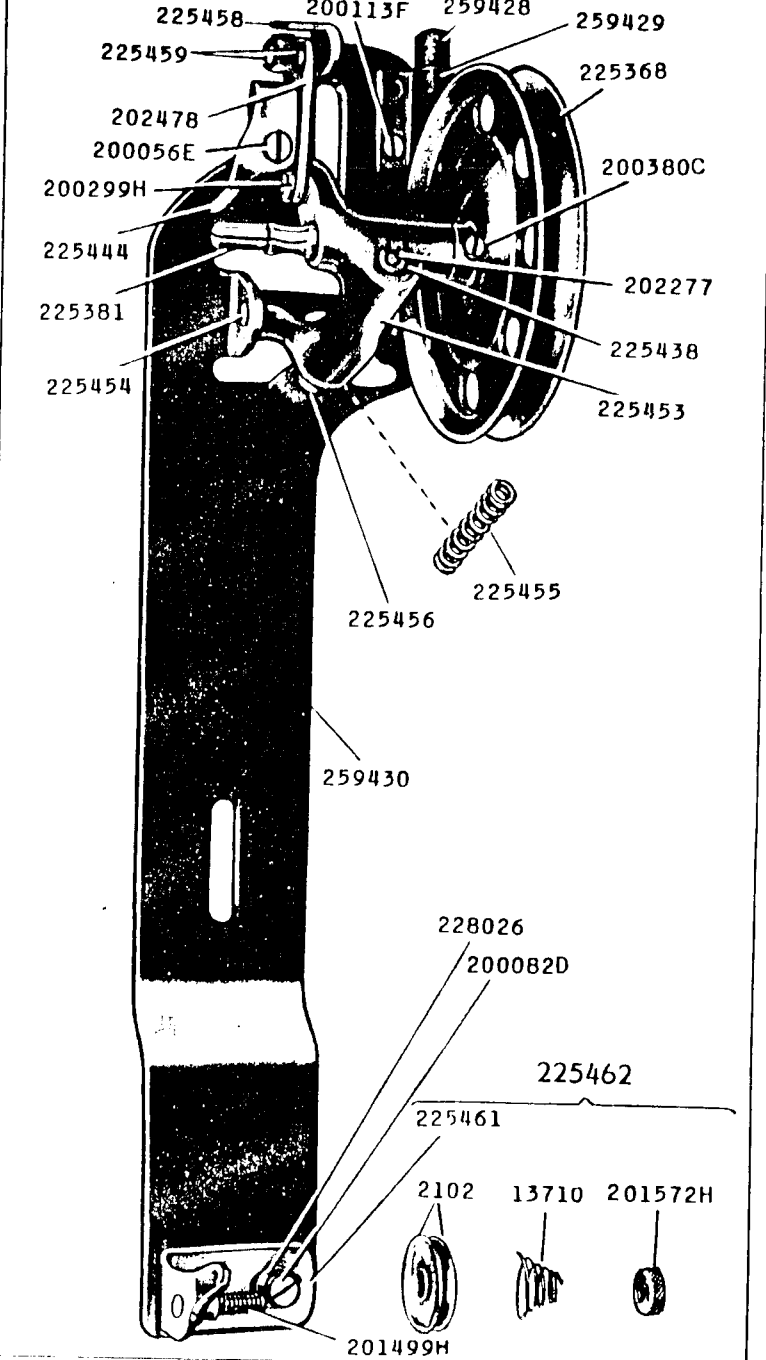

16762 - 3/8

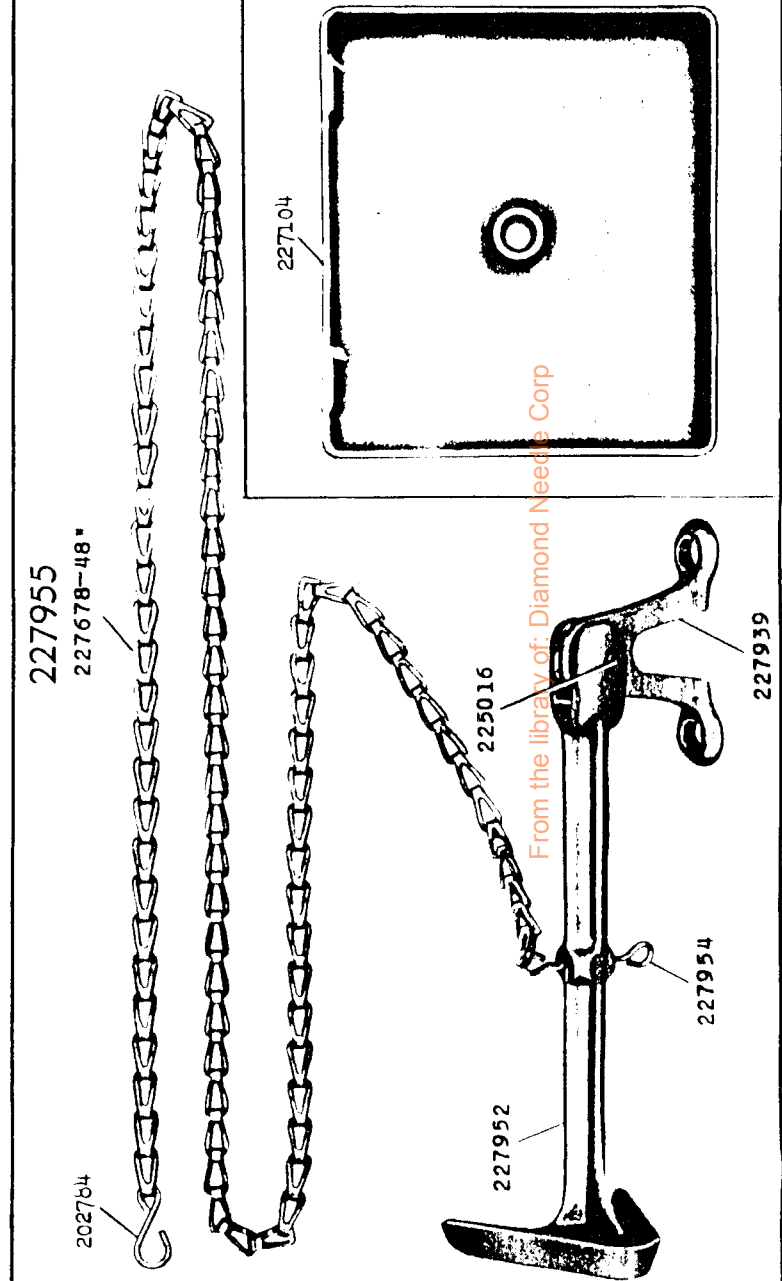

17002 - 1/2

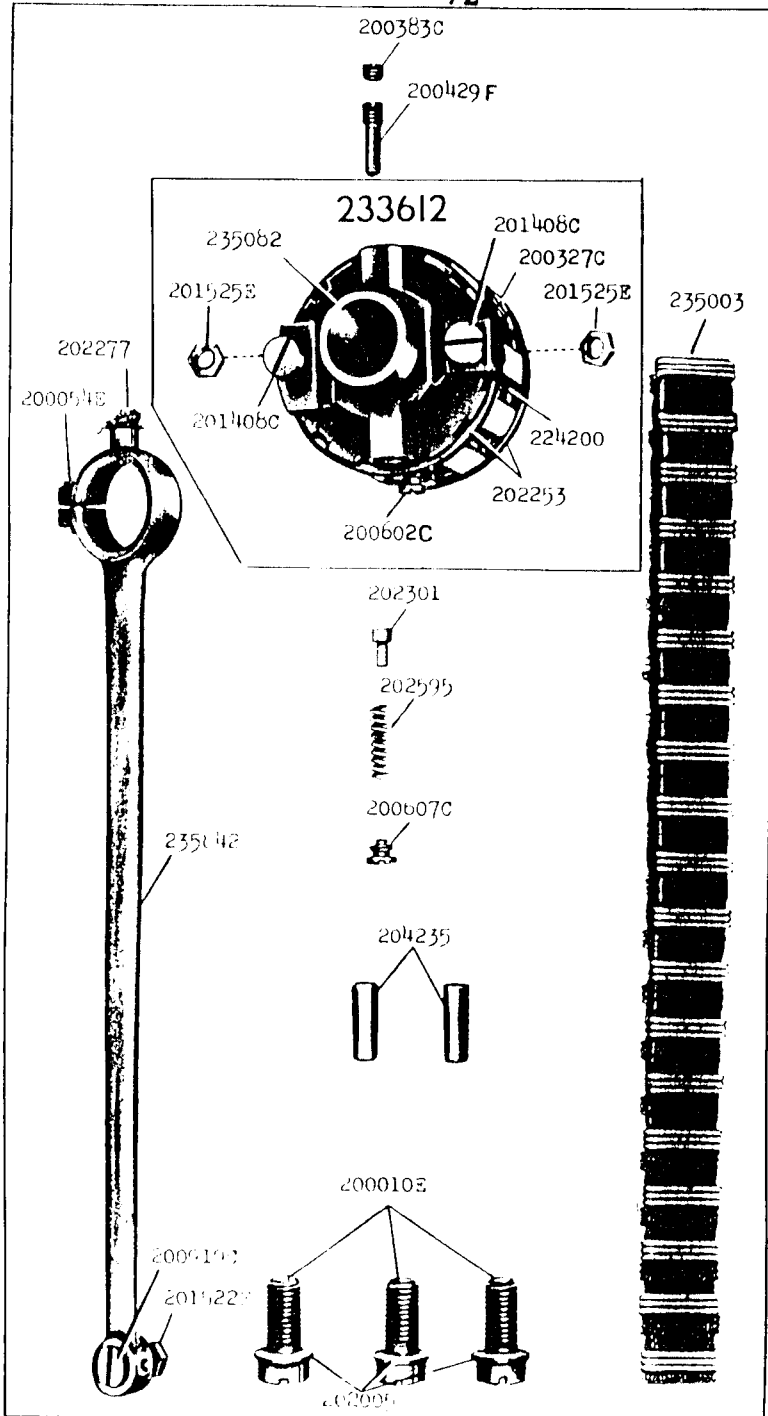

17003 - 1/3

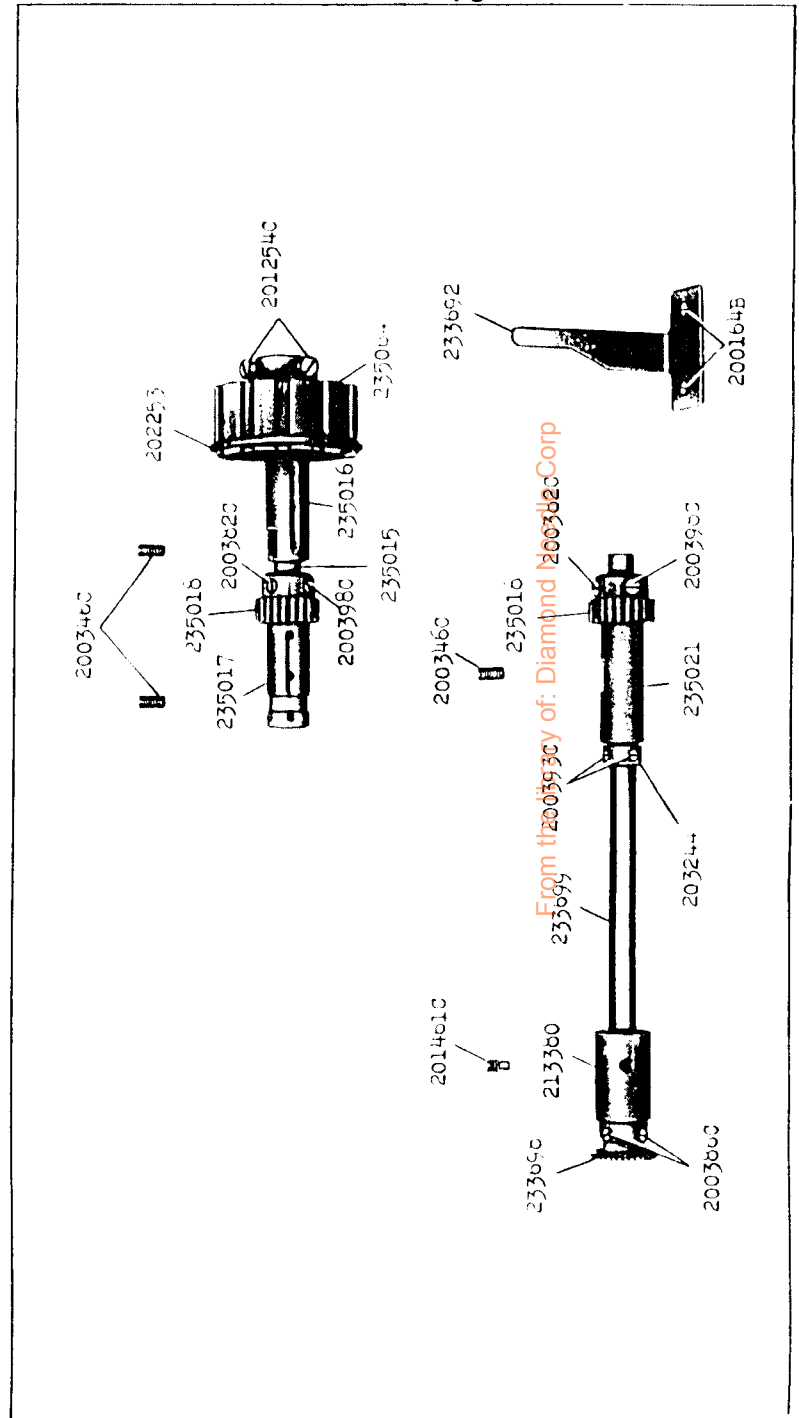

From the property of Diamond Drilling Corp

17030 - 1/3

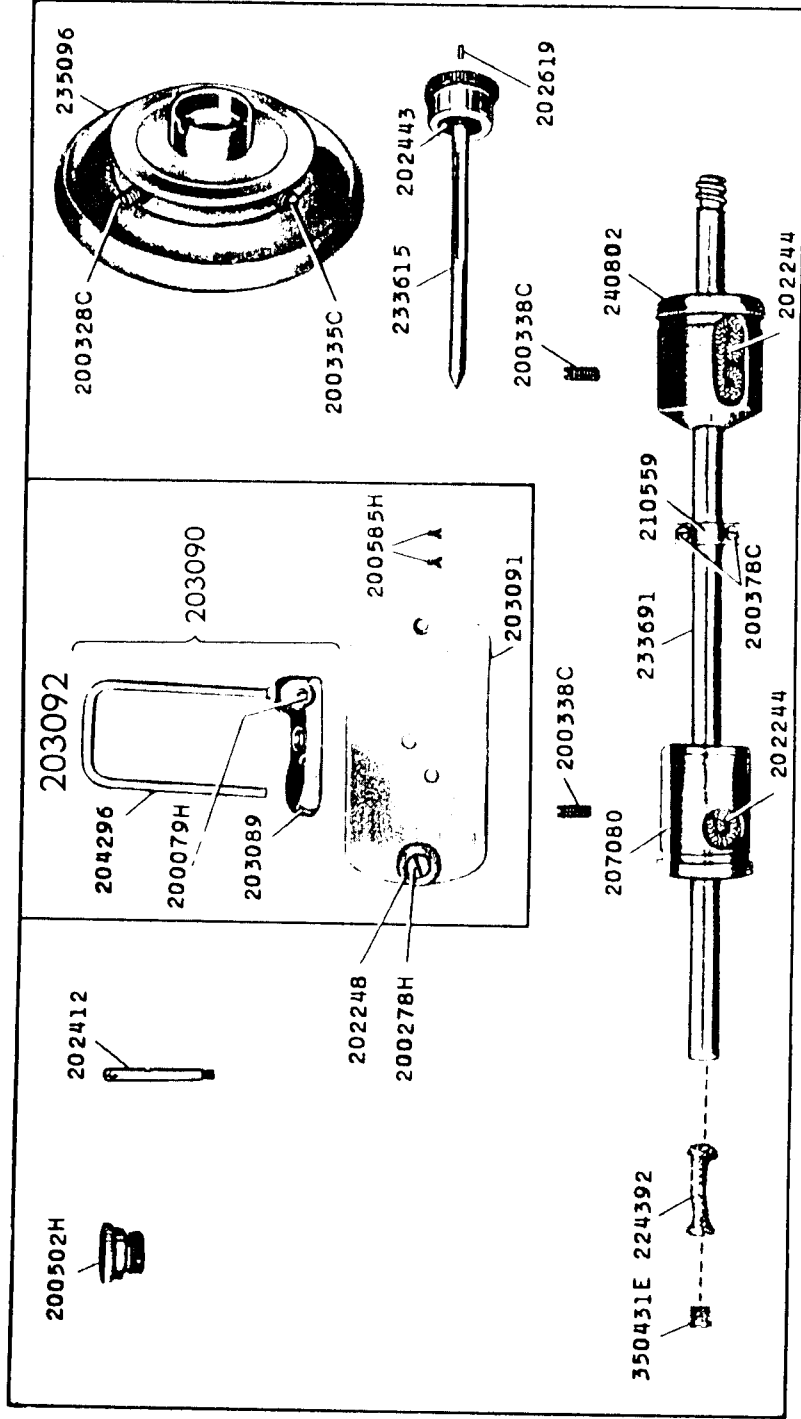

17038 - 1/2

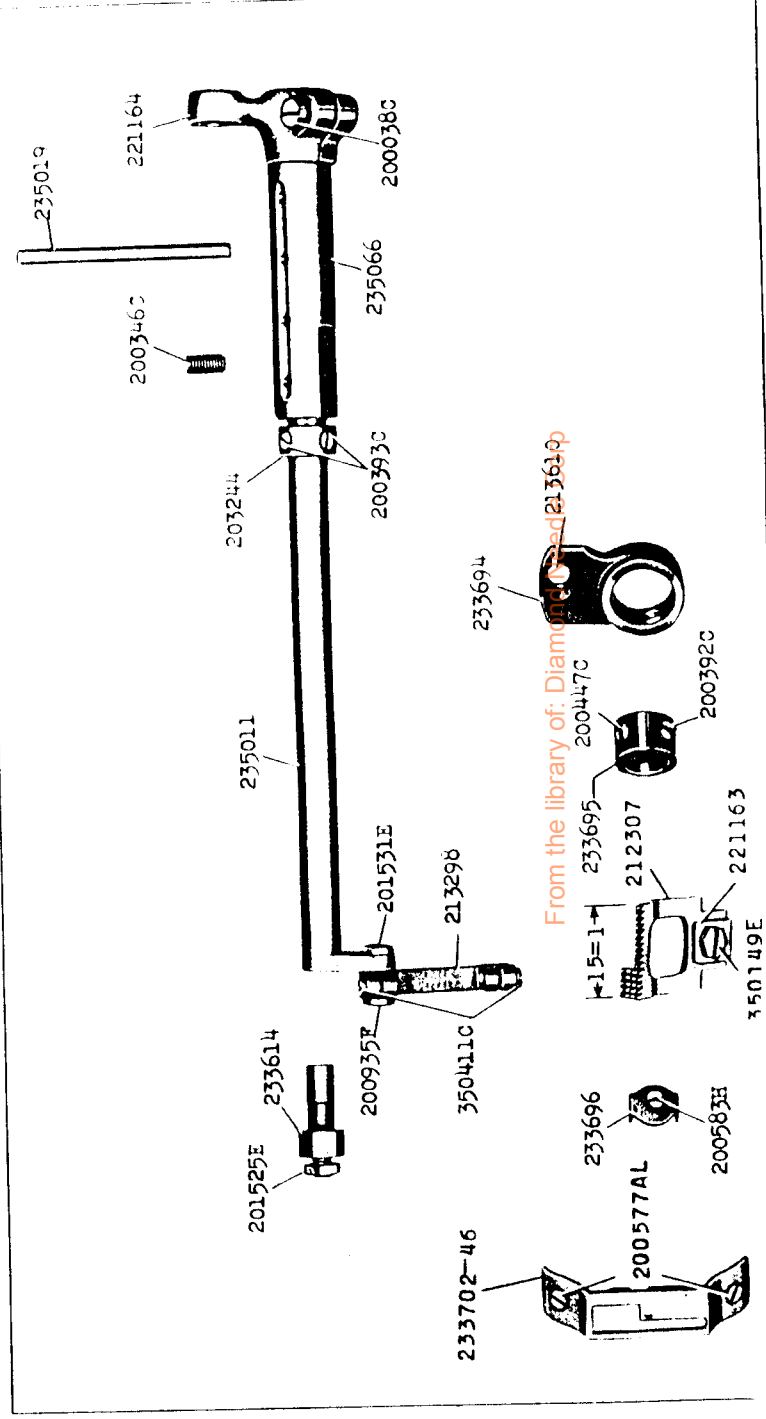

17010 - 1/2

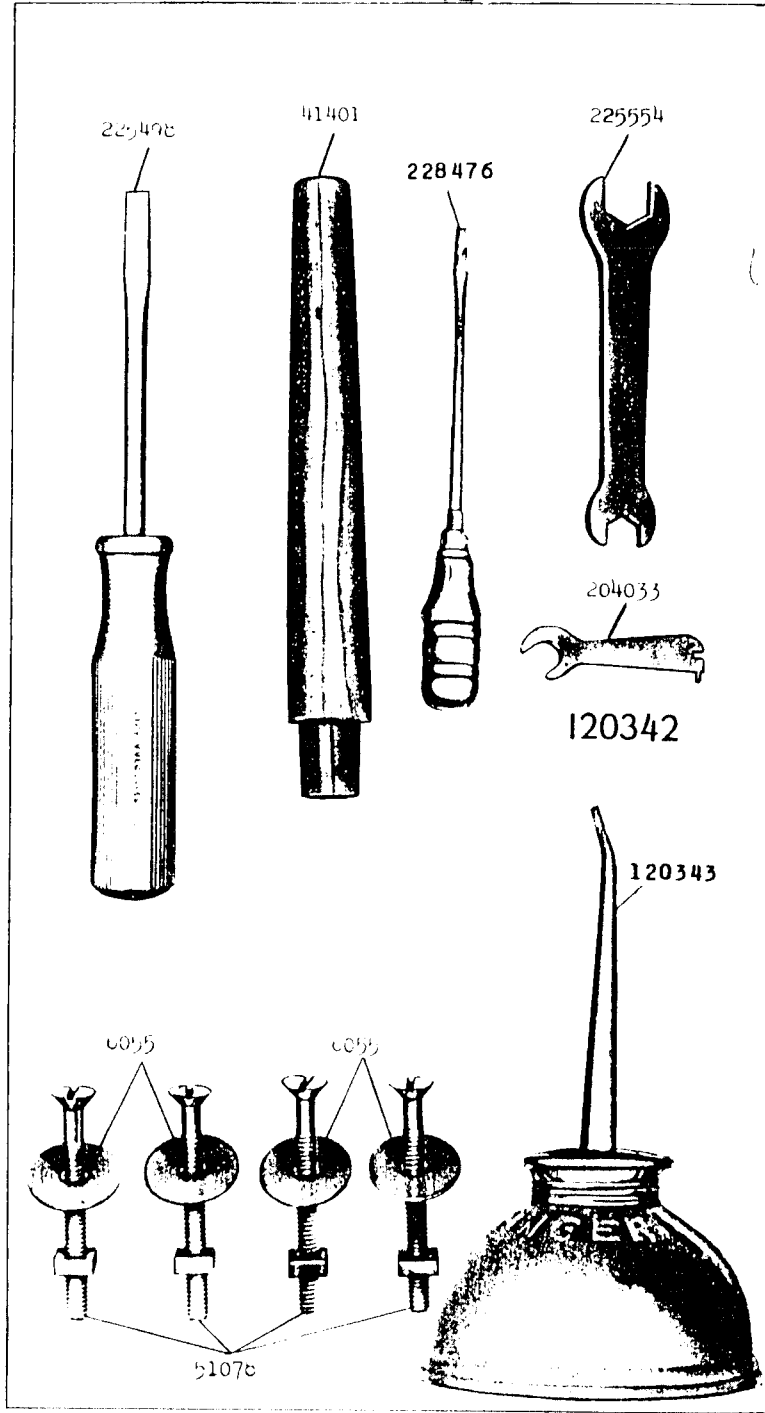

17024 - 2/3

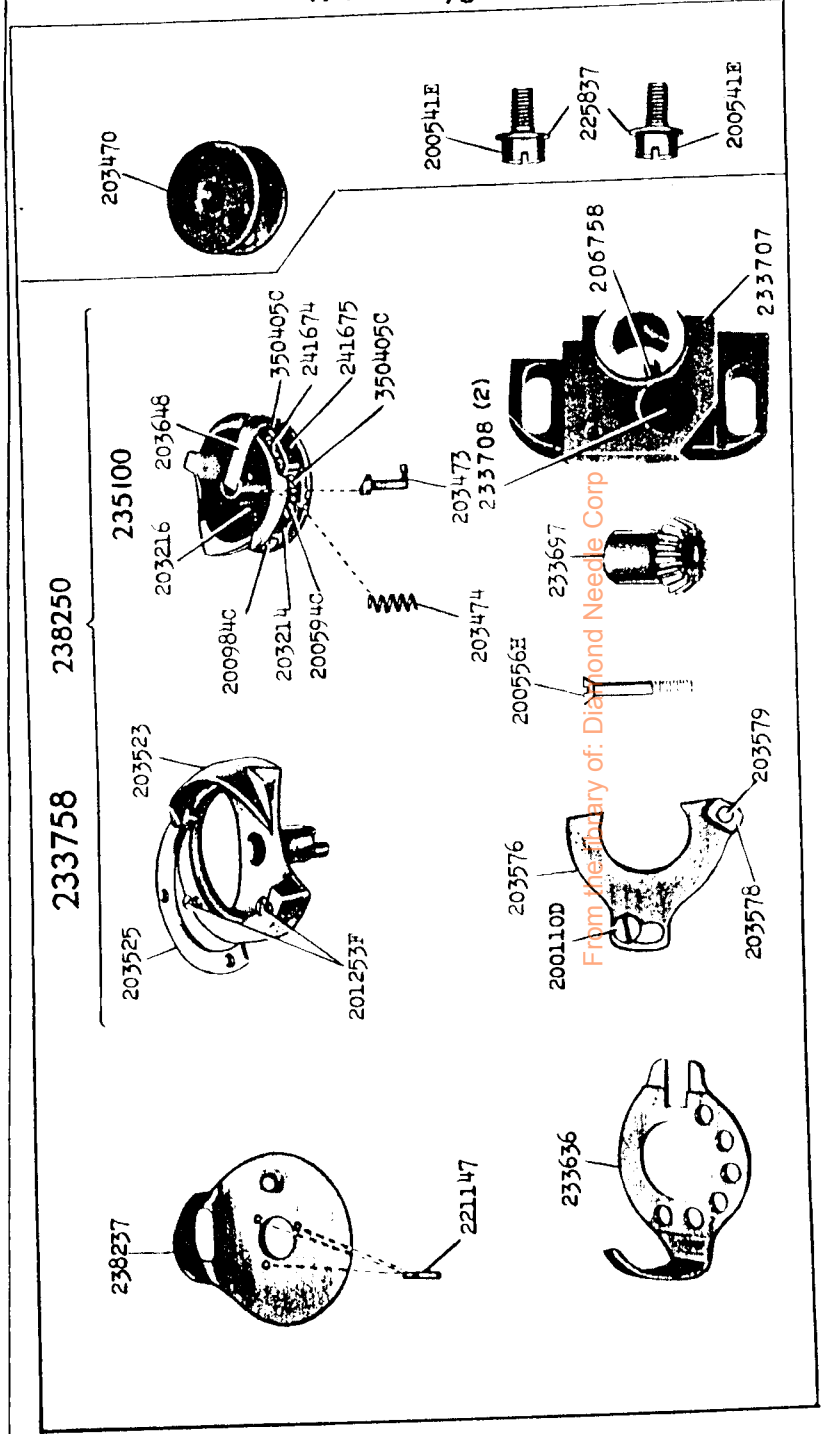

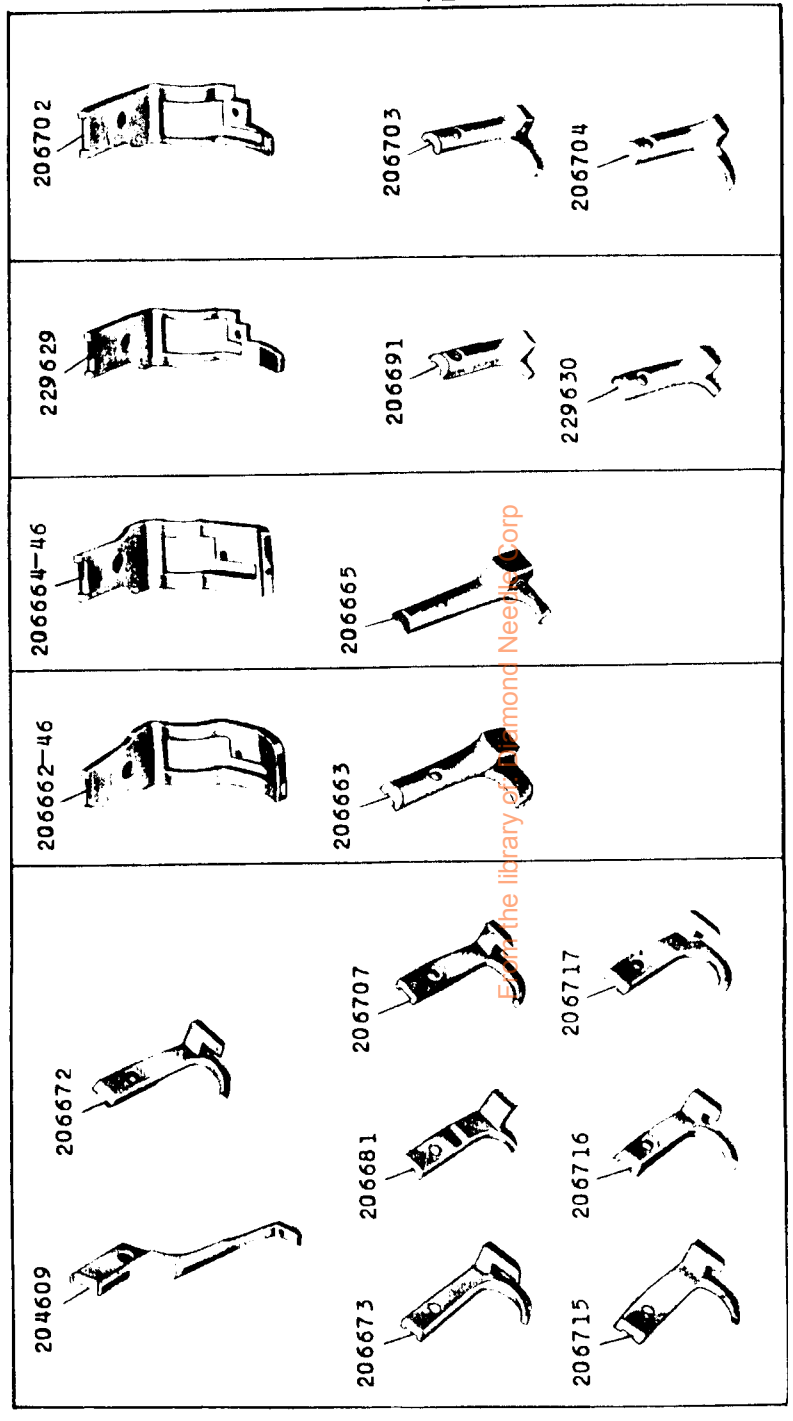
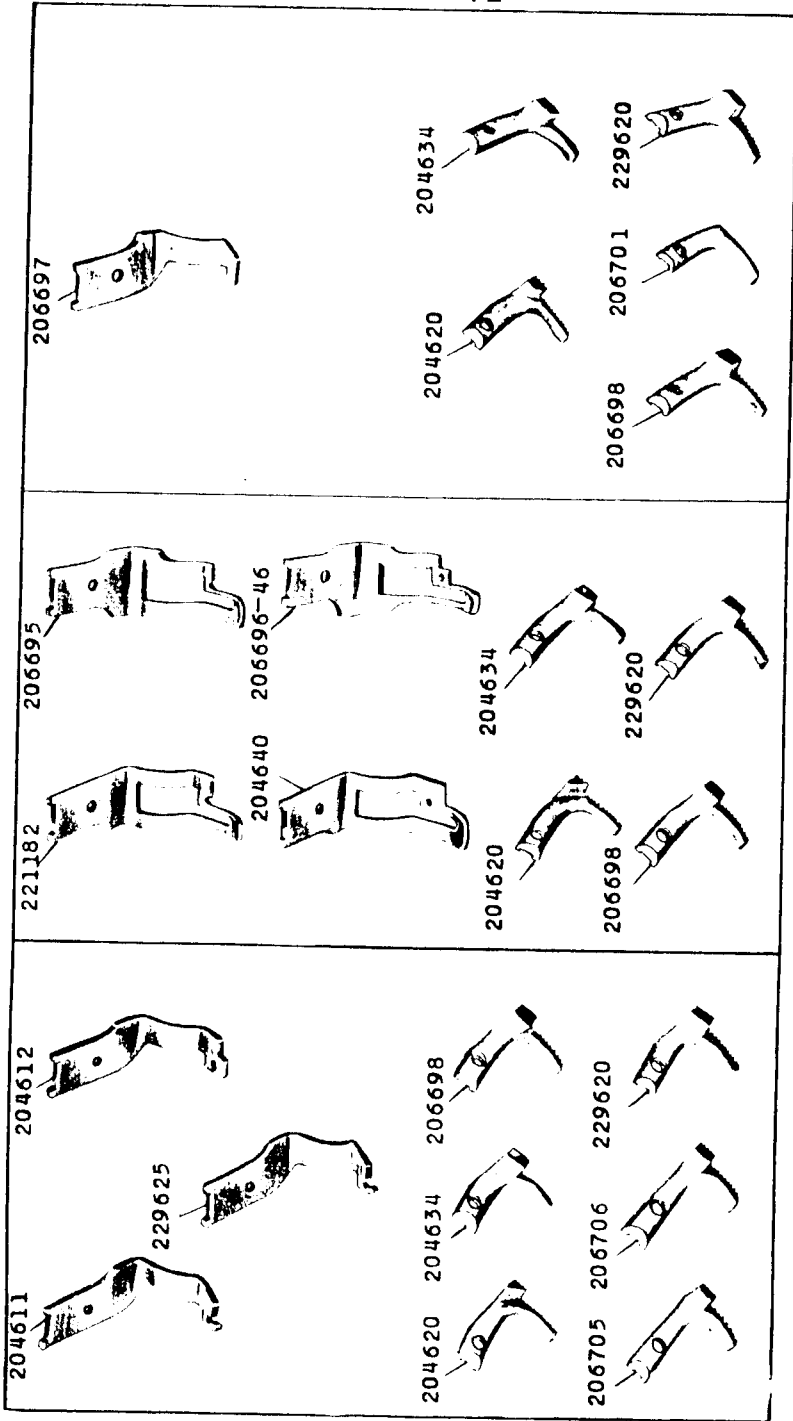

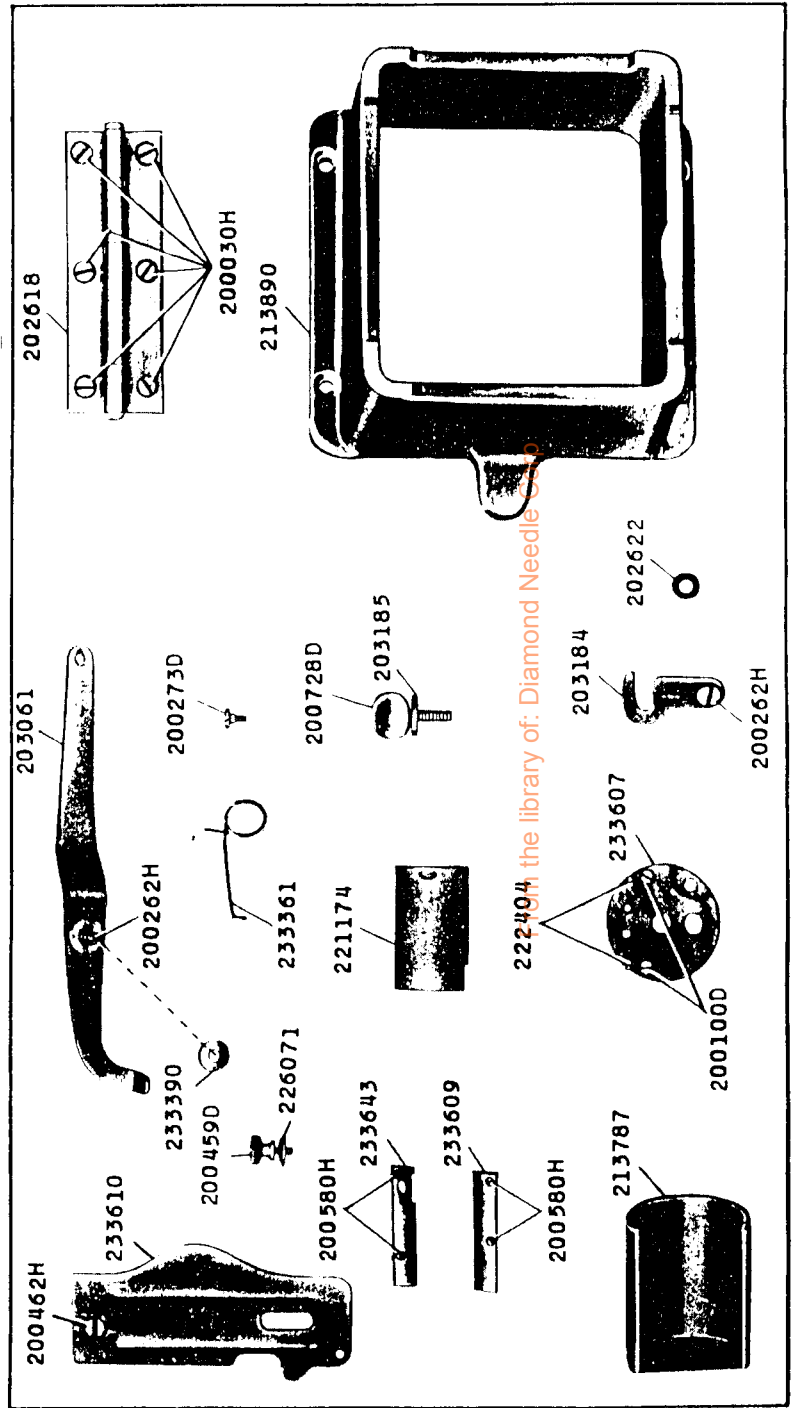
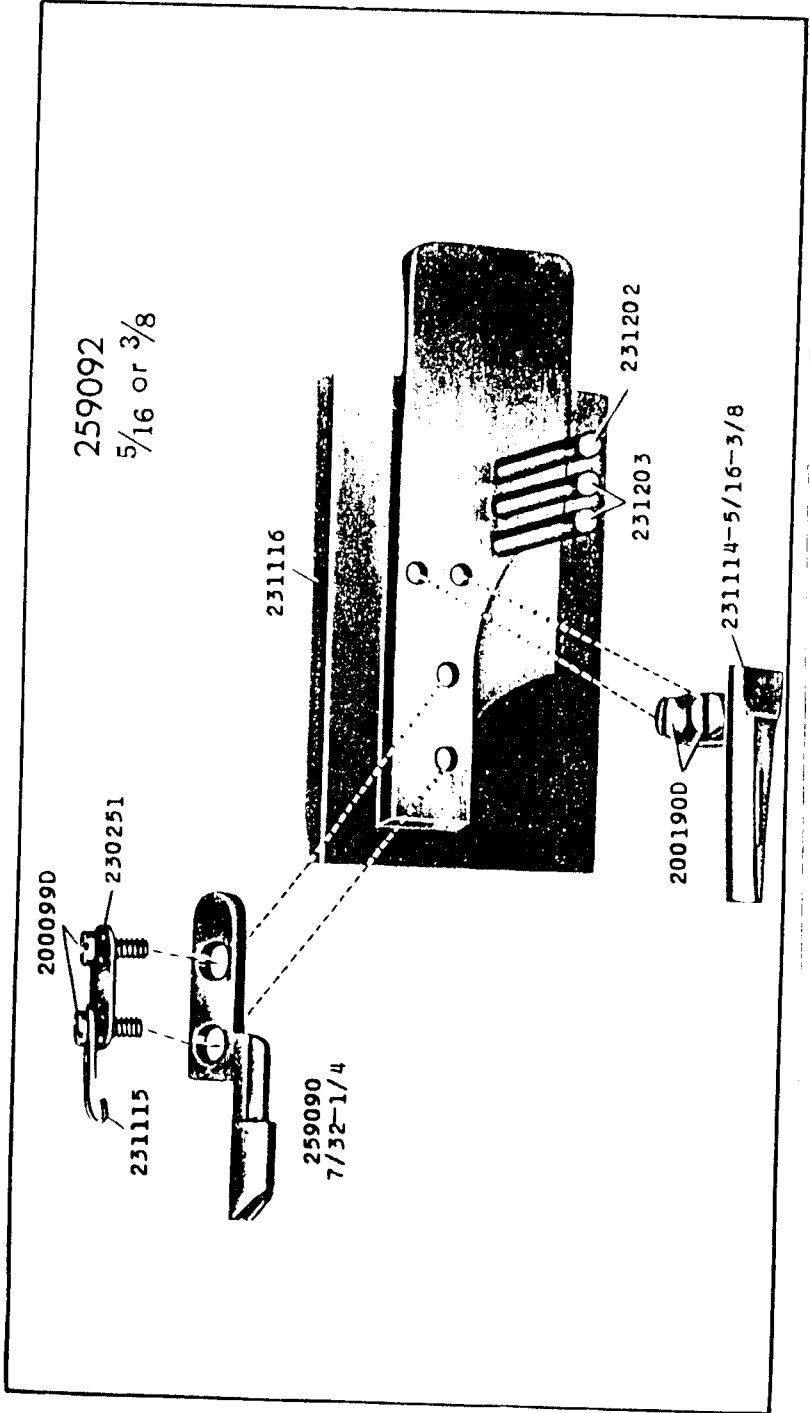

17041 - 1/2

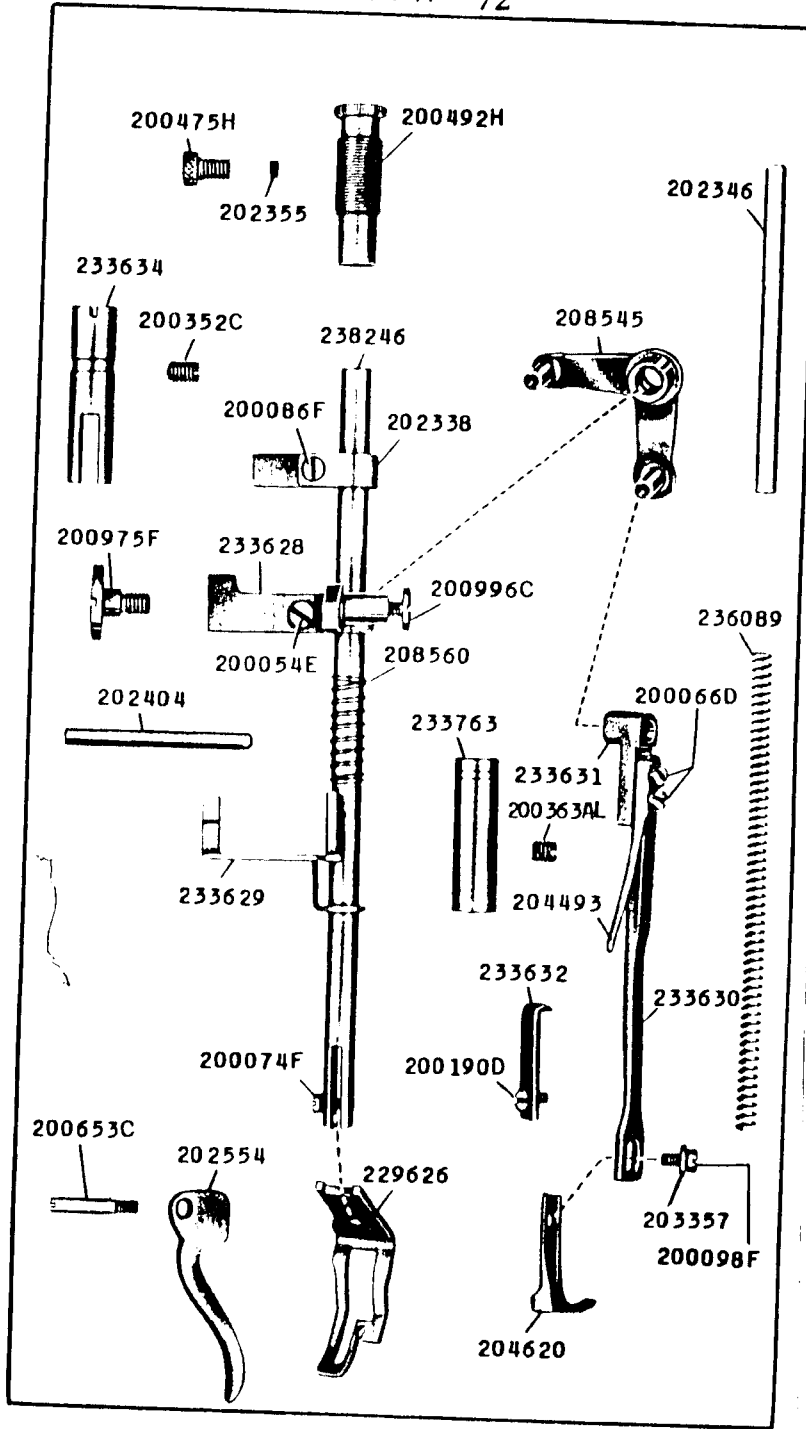

17042 - 1/2

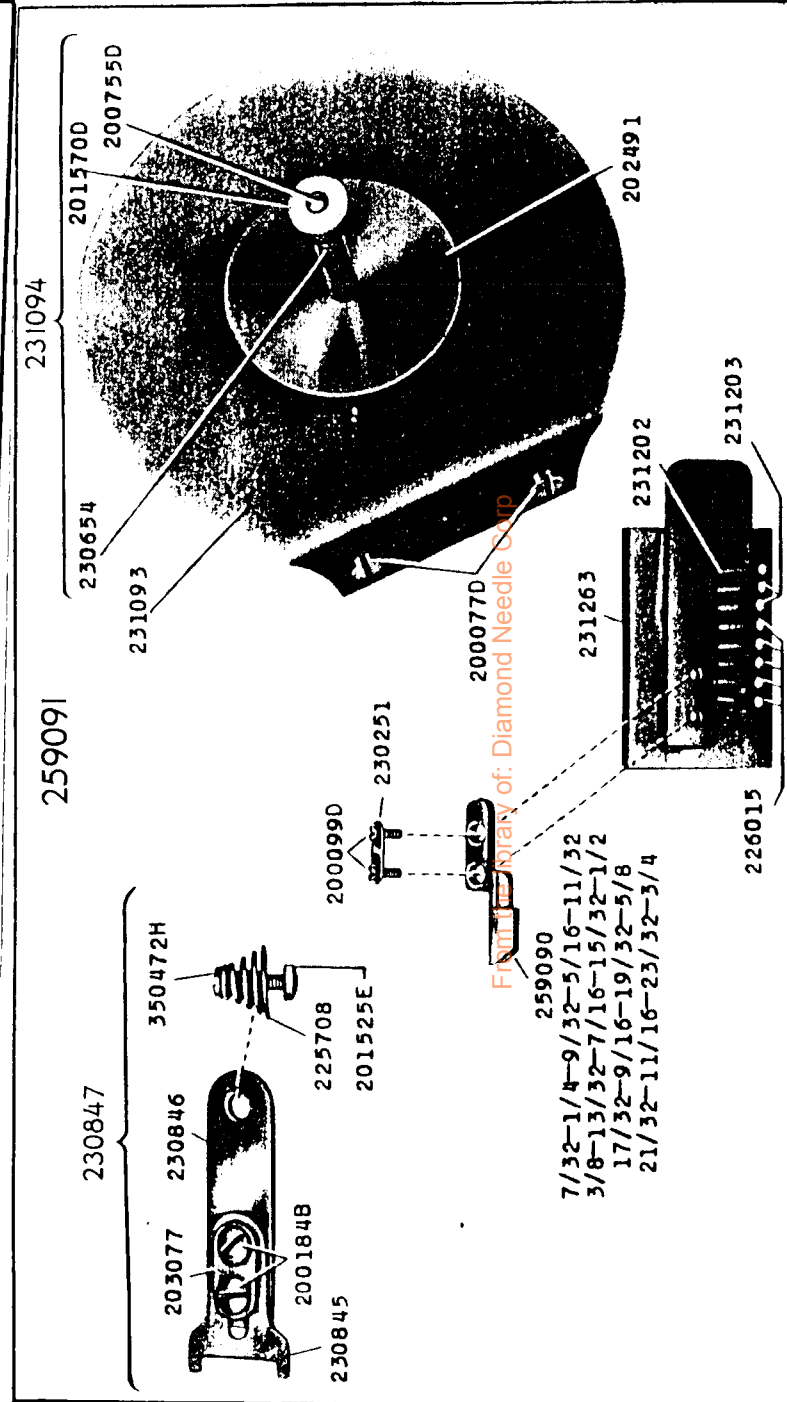

17039 - 5/8

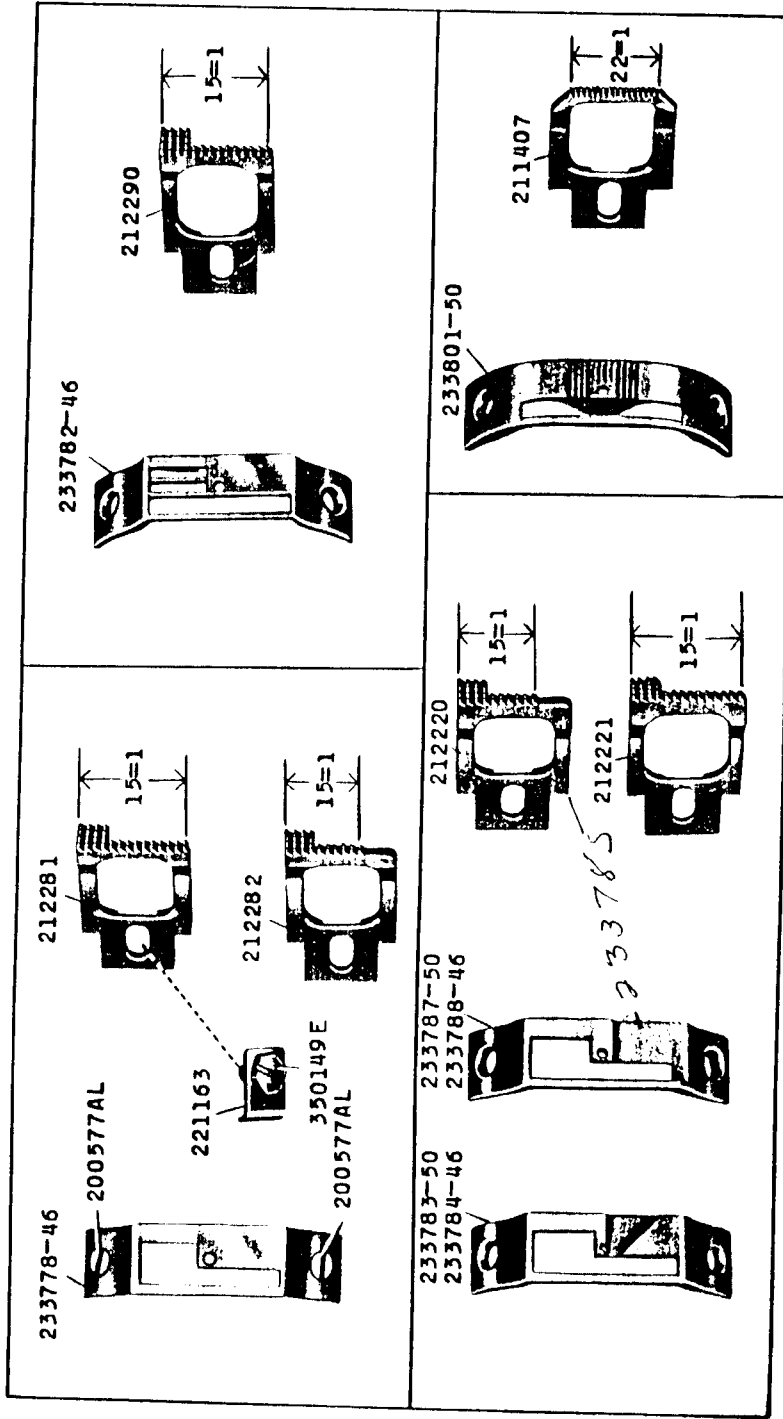

17040 - 5/8

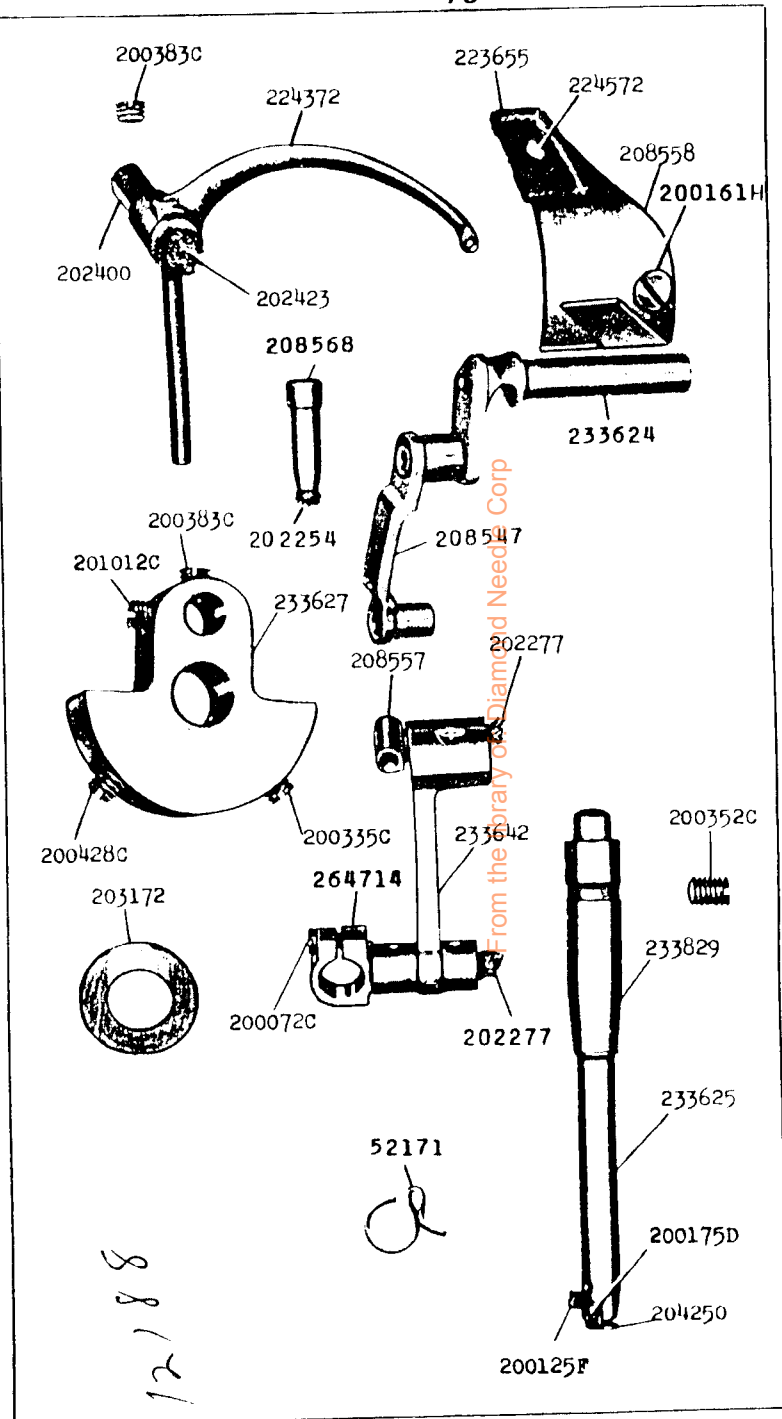

204604



204605



206674-40



206668

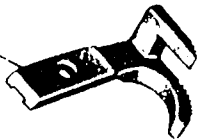

206675



206678

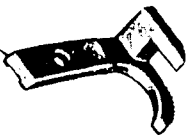

206714

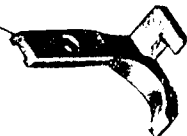

206719



204602



204603



229633



206672



206694



229628



206673

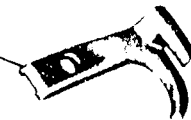

206707



206715



206716



206717

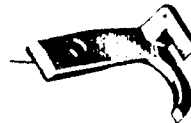

206692



204621



206693



From the library of: Diamond Needle Corp

